



Boldly Creative



Expert Customer Service



Focus On Quality



Ships Same Day

Patent(s) Pending

Rack Mount Monitor Tray

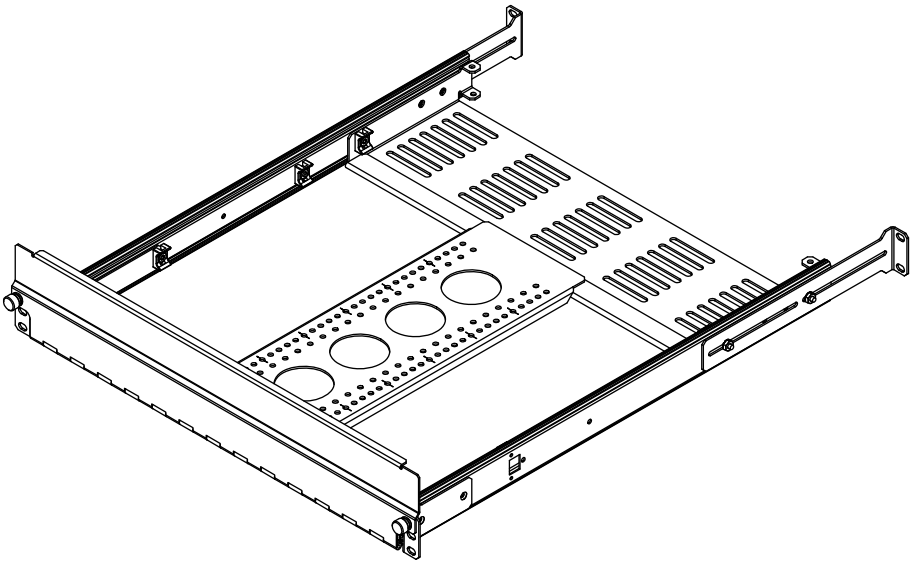

Installation Instructions
Kit P/N: 133-2279

Kit Contents

- (1) Partially Assembled Shelf w/Door
- (1) Cable (PS2 to USB)
- (1) Cable Power Cord
- (2) Rear Brackets
- (10) 11" Tie Straps

Rear Hardware Bag:

- (4) 8-32 x 3/8" Pan Head Screws
- (4) 8-32 Nuts

Rack Mount Hardware x8 Bag:

- (8) 12-24 x 1/2" Pan Head Screws Zinc
- (8) 10-32 x 1/2" Pan Head Screws
- (8) 12-24 Cage Nuts
- (8) 12-24 Square Nuts

Generic Monitor Hardware Bag:

- (4) 1/8" White Nylon Spacers
- (4) 1/4" White Nylon Spacers
- (4) Pan Head Screws M4x6mm
- (4) Pan Head Screws M4x25mm
- (4) Pan Head Screws M4x30mm

Dell 17V/19V Monitor Hardware:

- (4) 1/4" White Nylon Spacers
- (4) Pan Head Screws M4x14mm

Installation Instructions (4 Post)

Step 1. Mounting Depth: Measure the "Mounting-Depth" for your rack from the front of the "Front-Mounting-Surface" to the back of the "Back-Mounting-Surface".

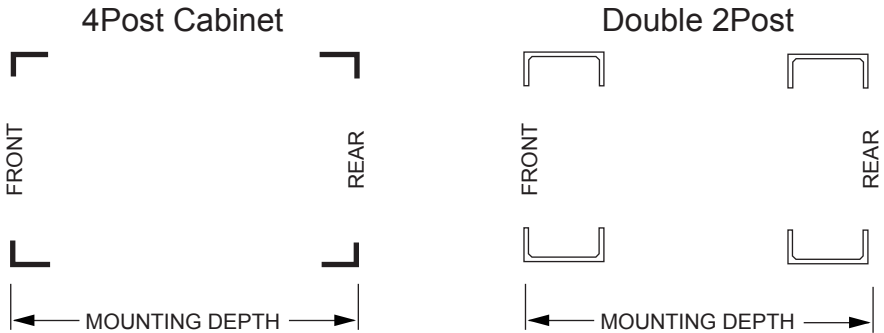

Step 2. 16.0" to 23.0": The Rear Rack Brackets will be installed as shown below for this "Mounting Depth" range (See Step 4 for assembly).

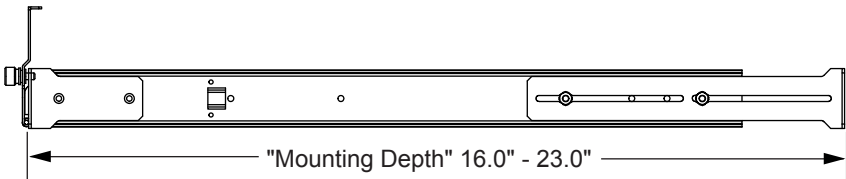

Step 3. 11.0" to 16.0: The Rear Rack Brackets will be installed as shown below for this "Mounting Depth" range (See Step 4 for assembly).

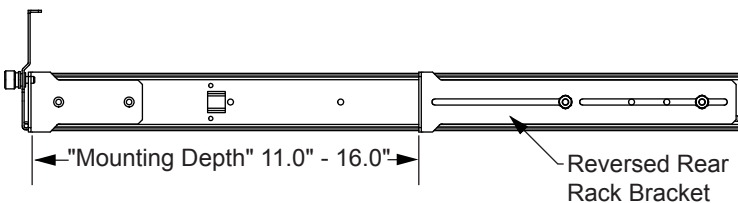

Step 4. Rear Bracket Attachment: Move the slide rails back approximately 10 inches. You may need to loosen the thumb screws to do this.

Attach the Rear Rack Brackets as shown below. Attach using (4) 8-32 x 3/8" Truss Head Screws and (4) 8-32 Nuts. The screws should be located in the slots as far apart from one another as possible (see below). Tighten all screws.

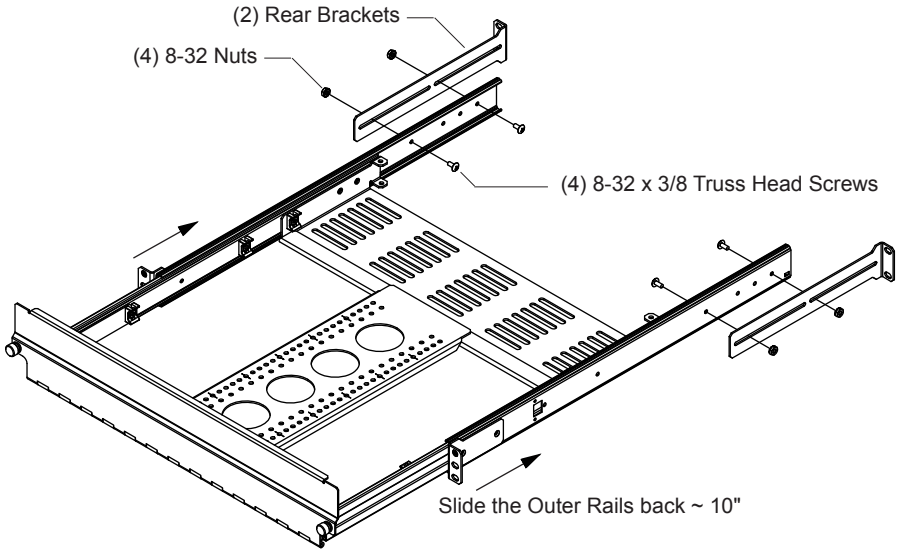

Note: If installing CMA refer to CMA instruction at this time.

Installation Instructions

- Step 5. Monitor Attachment:** Turn the monitor face down on a large flat surface. Locate the four VESA mounting holes on the rear of the monitor.
- Determine if spacers are required:** Some monitors have "recess" on the rear of the monitor. Spacers are provided to fill this gap. See Table A for spacer length options.
 - Determine Screw Length:** Only use the metric M4 screws provided. Screw length is determined by the spacers used (see Table A).

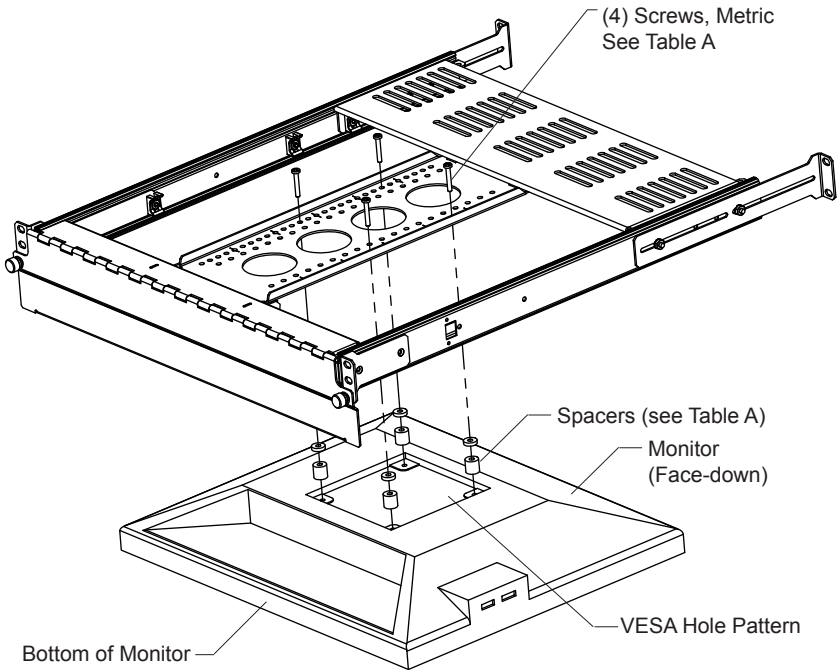

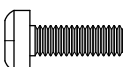





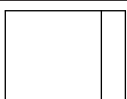



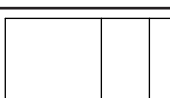



Table A

Recess Depth	Spacer	Screw
0		 6mm
.125 (1/8)		 12mm
.250 (1/4)		 18mm
.375 (3/8)		 18mm
.500 (1/2)		 25mm
.625 (5/8)		 25mm
.750 (3/4)		 30mm
.875 (7/8)		 30mm

Screws and Spacers are Shown to Scale

Installation Instructions

Step 6. Attach Shelf Assembly: Attach the shelf assembly to the rack as shown below using the Rack Hardware Kit.

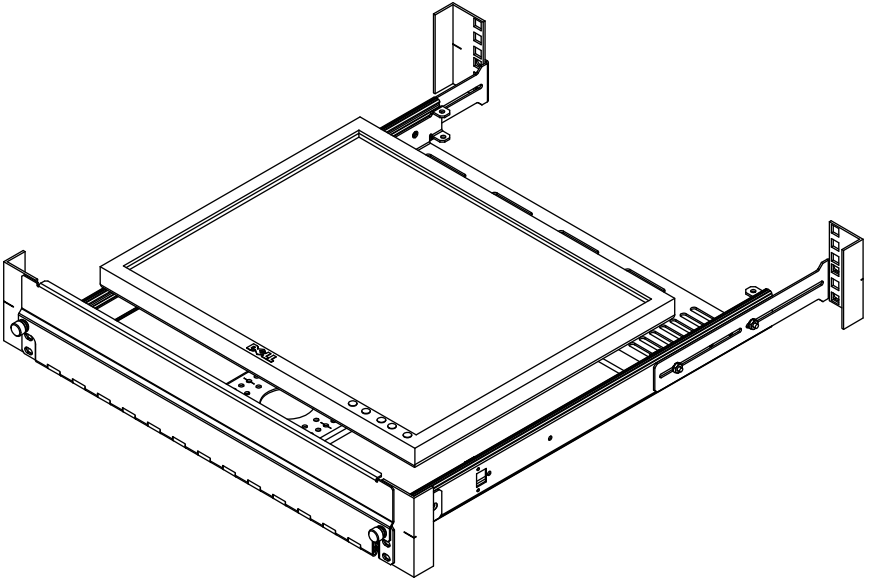



Boldly Creative



Expert Customer Service



Focus On Quality



Ships Same Day

Warranty Statement

Innovation First, Inc. warrants our products against defects in material and workmanship for a period of one (1) year from the date of purchase. Innovation First, Inc. liability shall be limited to repairing or replacing, at our option, any defective product.