

4 Post Mount
Overview

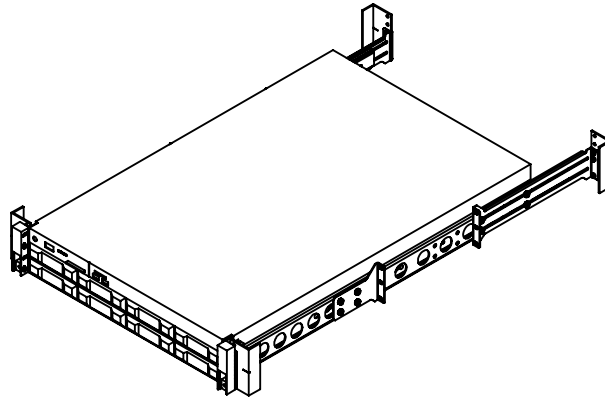

Front View

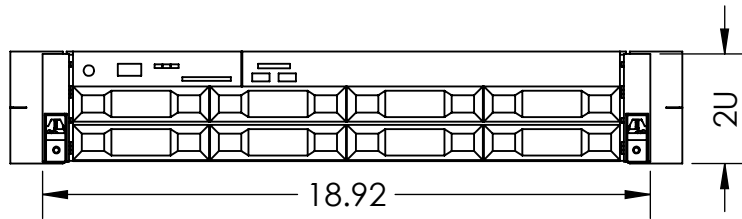

Inner Rail
Overview

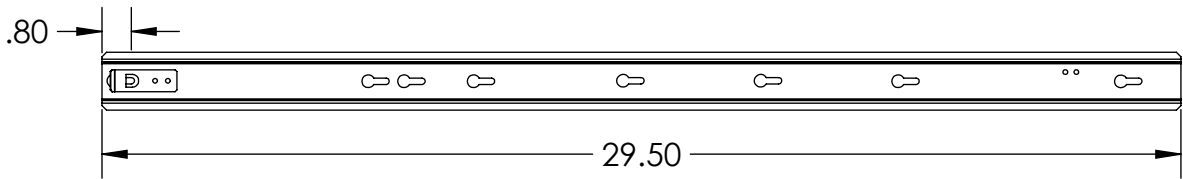

Outer Rail
Interior View

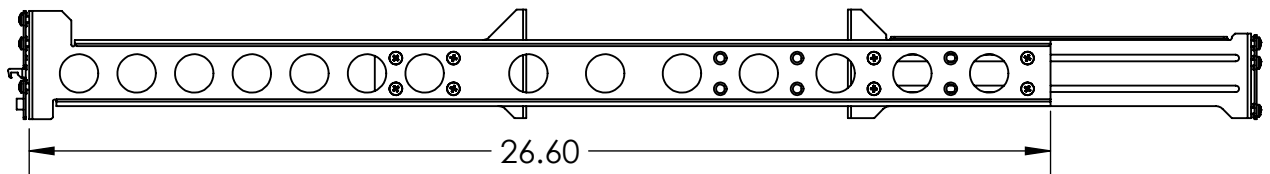

Outer Rail
Exterior View

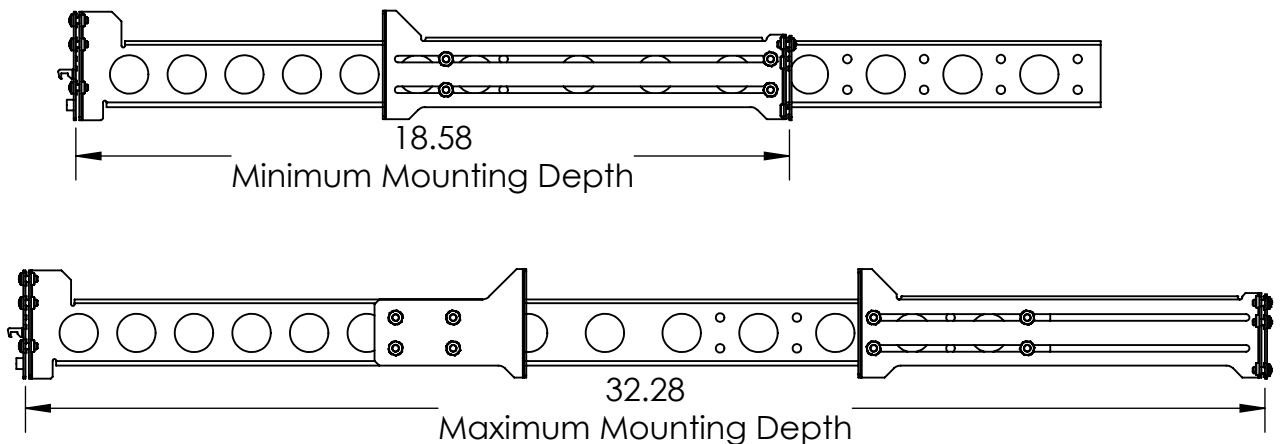

Tolerance ± 0.01

ALL DIMENSIONS ARE IN INCHES.

Printed on 3/11/2022

Sheet 1 of 2

RackSolutions[®]

Outline Drawing
racksolutions.com

Dwg No & Rev
122-6947-920

4 Post Mount Rack Fit Guide

Note:

A **positive** value indicates the answer to the corresponding question is **Yes**.
 A **negative** value indicates the answer to the corresponding question is **No**.

<u>Question</u>	<u>Formula</u>
Will the outer rail extend past the rack ?	$26.60 + T - D$
Will the inner rail extend past the rack ?	$28.47 + B - D$
Will the inner rail extend past the server ?	$28.70 + B - L$
Will the server extend past the rack ?	$L - D - 0.24$
<u>Variables</u>	B = Server Ear to First Button D = Rack Mounting Depth L = Server Length T = Rack Upright Thickness

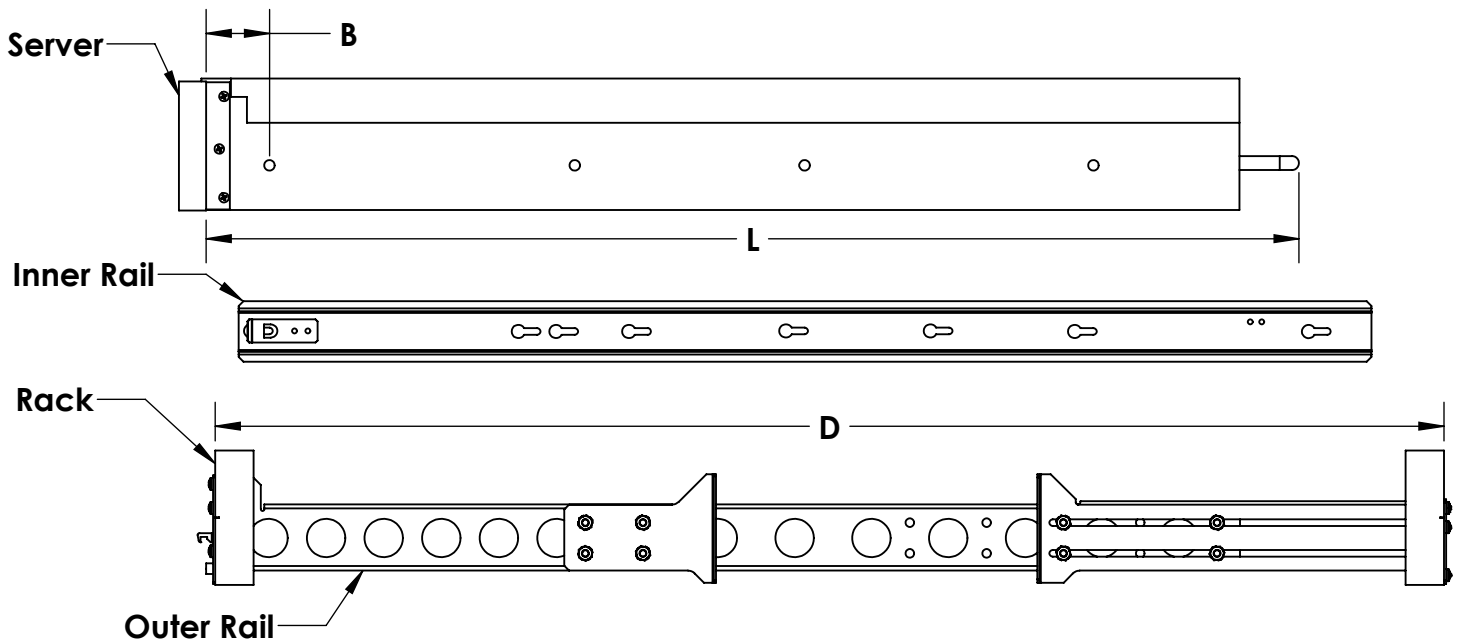
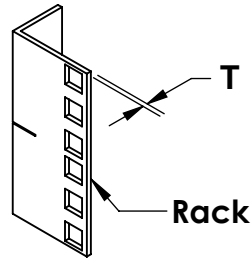

Tolerance ± 0.01

ALL DIMENSIONS ARE IN INCHES.

Printed on 3/11/2022

Sheet 2 of 2

RackSolutions®

Outline Drawing
racksolutions.com

Dwg No & Rev
122-6947-920